

# Our Sustainability Statement 2024

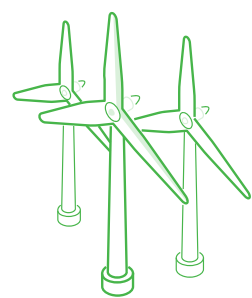

# 2024 Sustainability Highlights

## Taking climate action:

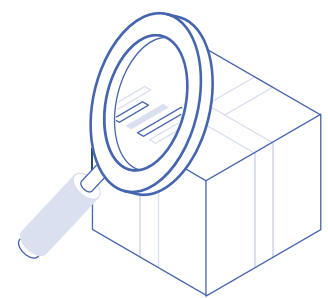
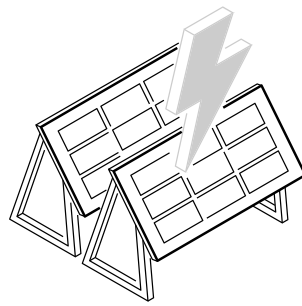

We have increased our solar energy production by **200%** from 2022 to 2024.

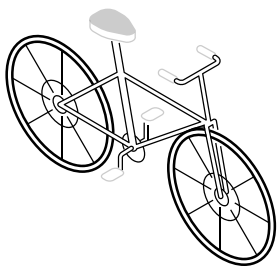

70% of our Bru Team vehicles are electric and will be **100% electric by 2027**. Our employees are also supported with Bru bicycles.

**ISO 14001**  
Environmental  
Management

Bru Textiles is proudly ISO 14001 certified, including all our mills. This means Bru has an **environmental management system** in place, ensuring continuous improvement.

## Responsible production and consumption:



100% of all new fabric collections launched in 2025 will be **eco composition** products, with an eco fabric percentage of at least 50%. In 2024 this percentage is 94%.

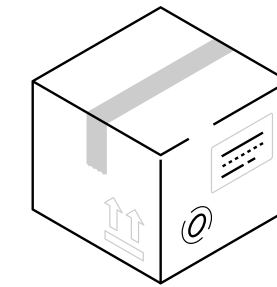

All our products are carefully packaged and shipped in **FSC cardboard and recycled plastics**. We do not use any virgin plastic to protect our products.

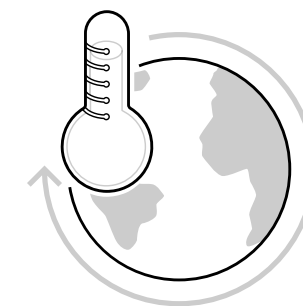

Our total CO<sub>2</sub> footprint, including the energy used to produce our products, has **decreased by 10%** from 2022 to 2023.

# Contents

<b>Introduction</b>	<b>4</b>	<b>SDG 8</b>	
• What is sustainability?	5	• Decent work and economic growth	22
• Why is sustainability important?	7	<b>SDG 12</b>	
• Relevance to business	8	• Responsible production and consumption	25
<b>Our Journey to Sustainability</b>	<b>9</b>	<b>SDG 16</b>	
• 2021 goals	10	• Transparency and Traceability	29
<b>Defining our Strategy - A Forever Company</b>	<b>11</b>	<b>SDG 17</b>	
• A Forever Company	12	• Partnerships	30
• The challenges we face	13	<b>Our Learnings Shared</b>	<b>31</b>
<b>SGD 13</b>		• Playbooks	32
• Understanding our carbon footprint	14		
• Products	15		
• Operations	17		
• Transport	20		



# Introduction



# What is sustainability?

Sustainability is the word on everyone's lips.

Heads of state, business leaders and consumers are asking what they can do to ensure sustainable practices. It is a question easily asked, but most certainly complex and multi-faceted when answered.

## The worldwide challenge

Through its activities, businesses have a substantial impact on the environment and society. From the natural resources used for production to the working conditions and jobs created, and the impact of the product life cycle, including production, logistics, use and end of life.

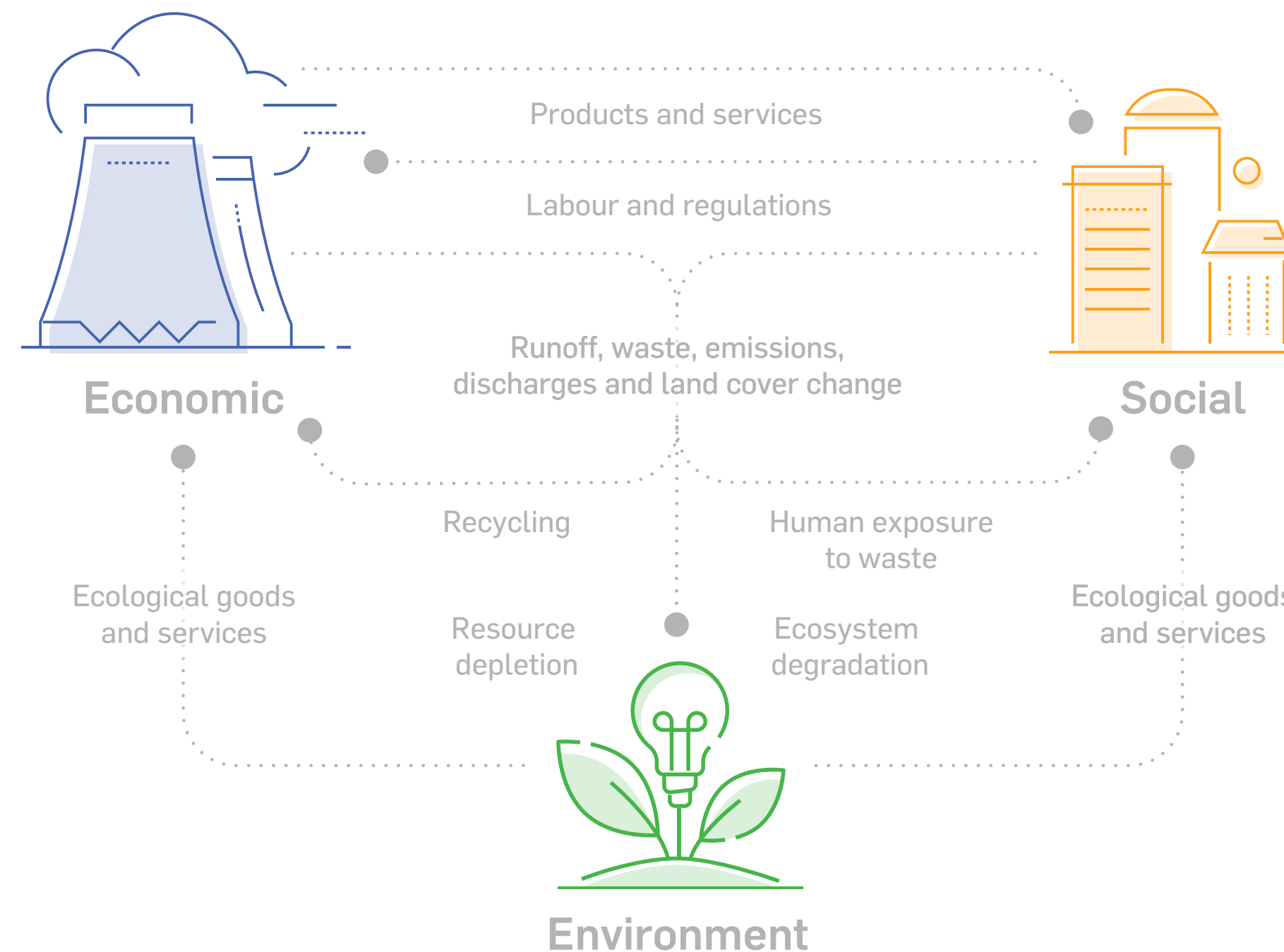

The worldwide challenge for businesses is to create profitable growth within the boundaries of:

-  People
-  Community and society
-  The planet
-  Climate and environment



# Sustainable Development Goals (SDGs)

To offer a unified agenda on sustainability, the United Nations developed the [Sustainable Development Goals](#) (SDGs). They are a set of universally established ambitious goals which form an action plan that addresses the urgent environmental, political, and economic challenges facing our world.

## Universal goals

Since any decision that a business takes will have an impact on at least one of the SDGs, businesses need to integrate sustainability into every aspect of their operations. The SDGs simplify this integration by providing universal goals that businesses can contribute towards, providing greater reference points when making strategic decisions, which help to clearly understand the potential positive or negative impacts their business decisions have on sustainability.

The SDGs strategic shared alignment and main purpose is to combat climate change and create a better, safer environment for all by 2030.

## 17 Goals

The SDG consists of 17 goals and 169 specific targets approved by governments, businesses, and other organisations.

## 2030

The collective goal for shared alignment to a unified blueprint and global partnership, to ensure a safer environment for all by 2030.



# Why is sustainability important?

When establishing sustainability strategies, businesses implement environmental, social and governance (ESG) metrics to assess ethical practices and environmental impact.

## For customers

These important metrics align the company vision and business strategy, delivering on customer expectations and fostering a path towards sustainable solutions and innovations.

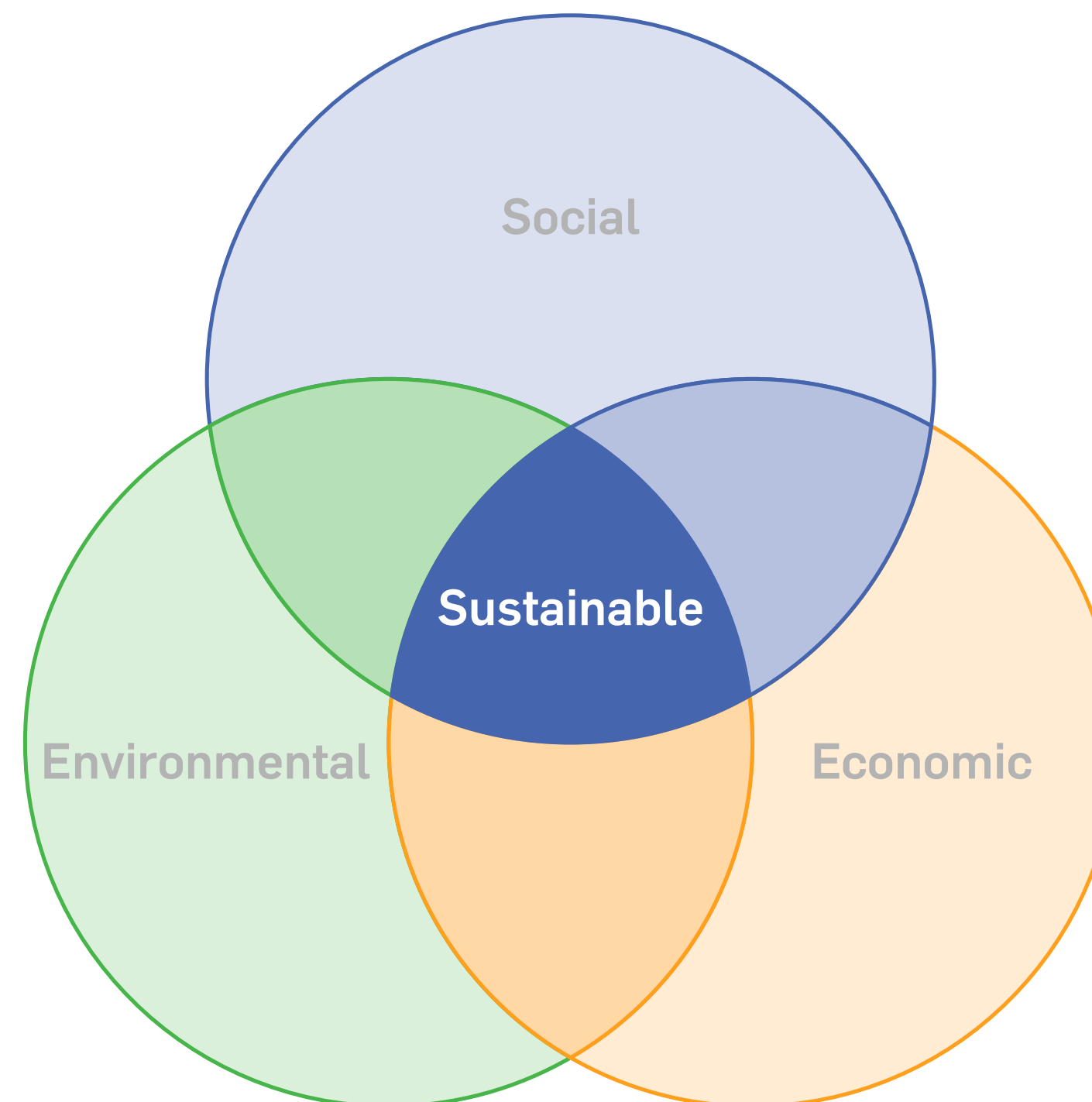

## For society

From a societal perspective, sustainability is further reaching than a Corporate Social Responsibility (CSR) / Corporate Social Investment (CSI) strategy. Sustainability looks to solve human rights issues, including universal hunger, poverty, good health and well-being, quality education, gender equality and decent work and economic growth. Business needs to define the role they play in these areas, and how best to ensure their employees and broader communities are supported by good business practice.



# Relevance to business

Sustainability today, for many businesses, is a driver for change, innovation, and new growth. Incorporating sustainability into the business model creates benefits over time, both within operations as well as throughout the general market:

## The common goal

The greatest impact sustainability strategies hope to achieve is the transition towards green energy resulting in a CO<sub>2</sub> reduction, and the prevention of biodiversity loss. Much of what we are trying to achieve with carbon reduction today is linked to the [Paris Climate Agreement](#), signed in 2015 by 196 parties across the world. This is a tall order and requires that CO<sub>2</sub> emissions be cut by approximately 50% by 2030.

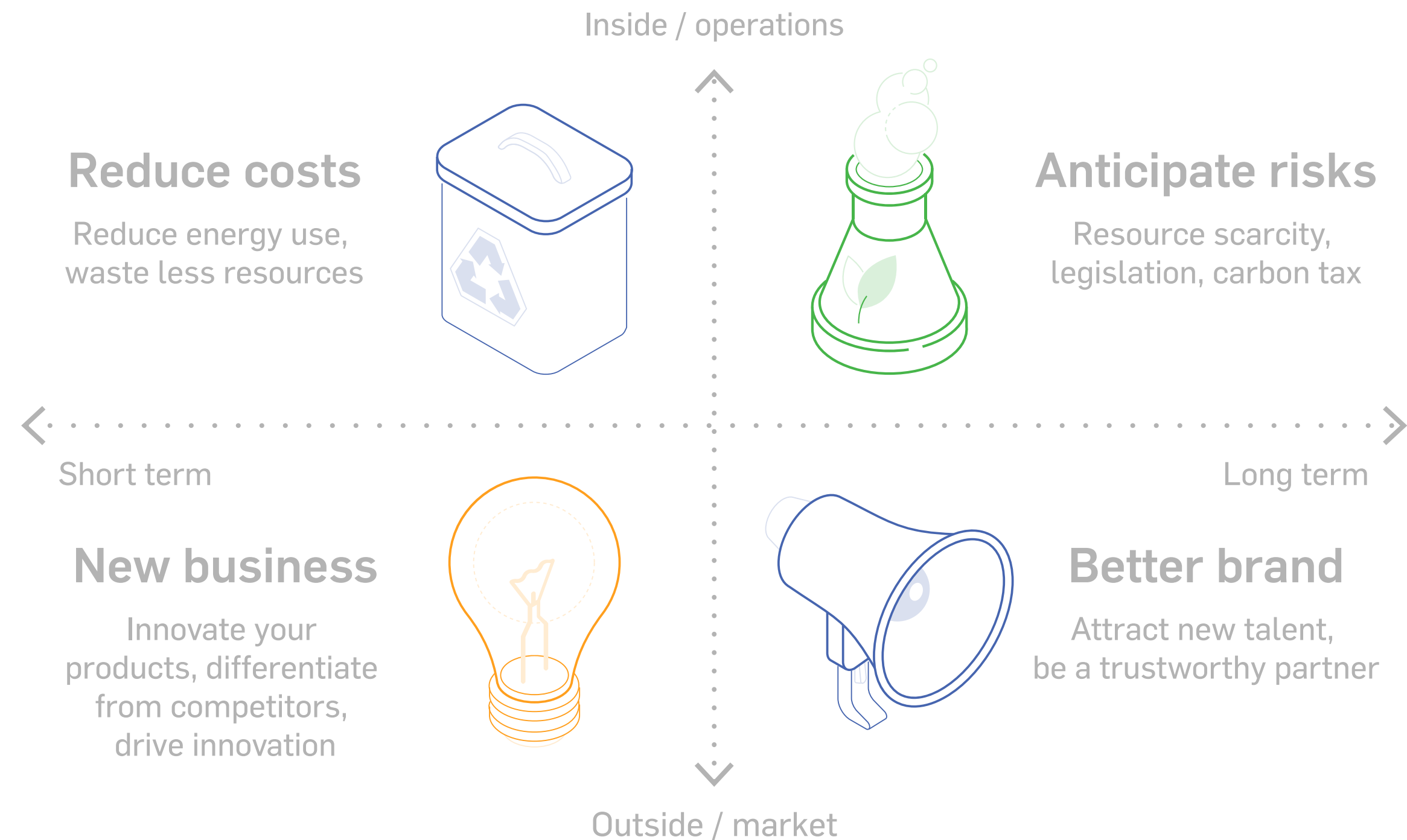





# Our journey to sustainability



# 2021: Where we started

At Bru, our drivers for growth have always been created in collaboration with our employees, partners, customers, and suppliers. The process is collaborative, consultative and grounded in an approach that asks us to think about the future we all want.

## Laying the foundation

At first, our approach was practical. What metrics could we immediately functionally control, and these became our five ambitions, where we would:

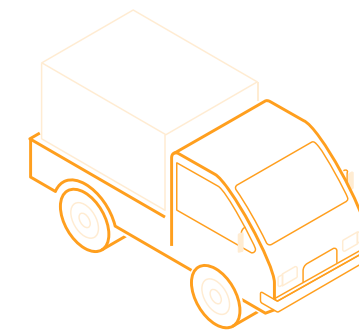

01

Leverage data to reduce the kilometres travelled by our products and people, and re-think where we keep stock

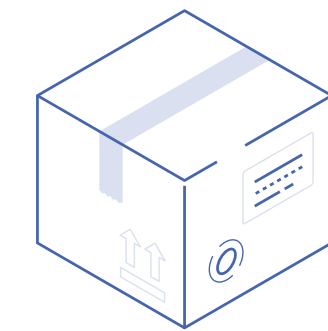

02

Rethink packaging holistically in our value chain to reduce the environmental impact

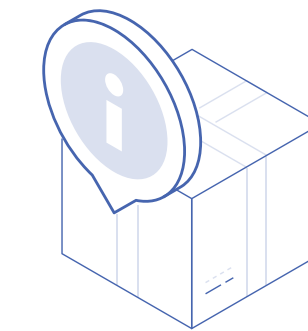

03

Raise the bar for Bru suppliers and nudge suppliers to become more sustainable

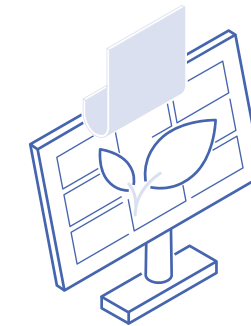

04

Continue to lead the way in digital fabrics in the textile industry

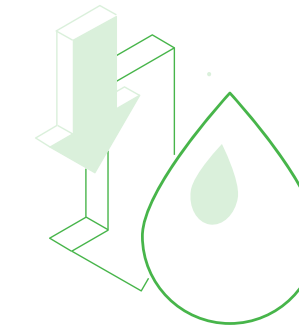

05

Reduce the environmental impact of our operation

## What we discovered

We realised, however, that these ambitions needed to be extended if we were to make lasting, more impact driven change. It was this defining moment that helped us form a partner relationship with [Futureproofed](#) and their team of experts. It has been from this point that our journey towards sustainability has become enriched and expanded upon.

# 1,5°C target

It is Futureproofed's mission to enable cities and companies to move to a 1,5°C trajectory and reduce greenhouse gas emissions in order to limit global warming.



# Defining our strategy





Bru Textiles strives to become **A Forever Company**, creating a positive impact and delivering change to ensure a sustainable future for generations to come.

To do this, we are strategically molding our business vision and evolving our sustainability actions according to the UN Sustainable Development Goals (SDGs), and the relevant SDGs within this framework.

## The impact of the textile industry

The entire textile industry is the **third largest contributor** to greenhouse gas emissions, and although we are separate from the apparel and fashion industry, the interior and exterior furnishing fabrics industry needs to ensure we partner and innovate towards sustainable textile production, transportation and educating consumers regarding purchasing decisions.

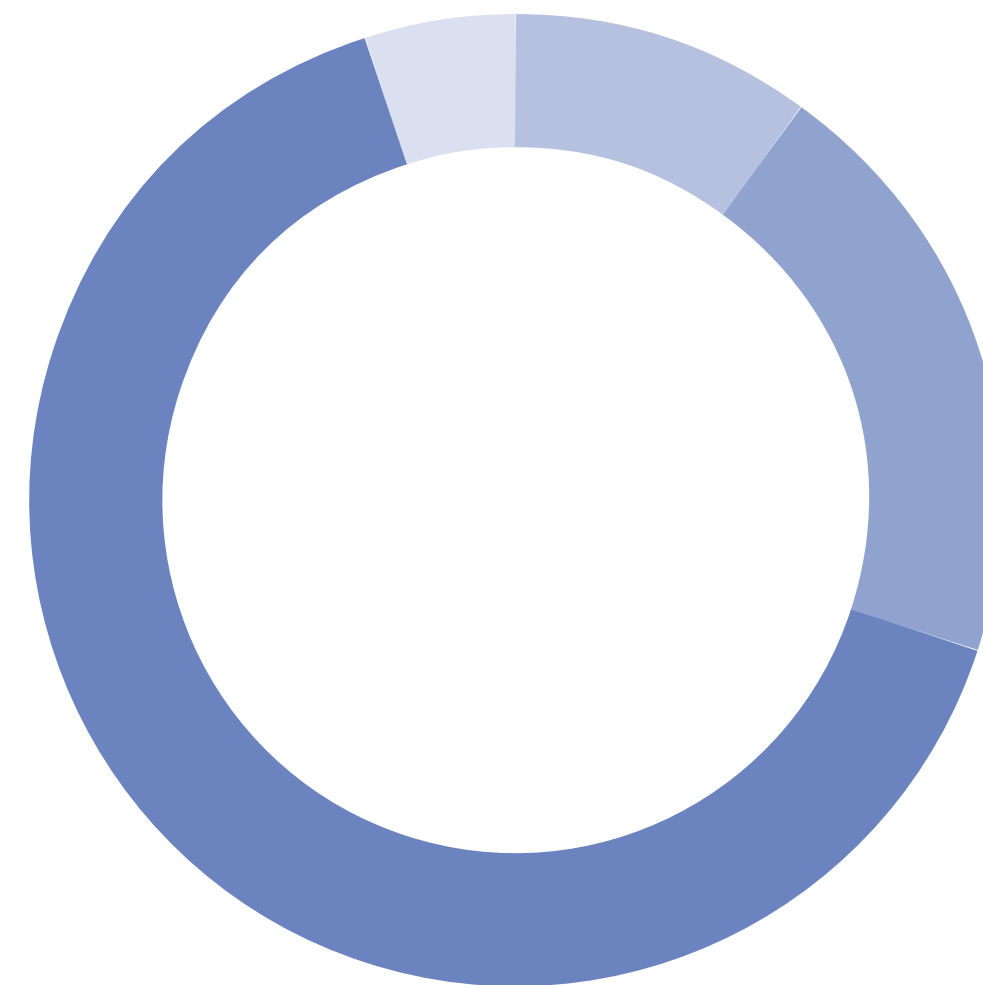

When compared to fashion, interior and exterior household furnishing fabrics are more durable, require fewer washing cycles and have greater longevity.

However, we are committed to our responsibility to ensure we find solutions for better products and product life cycles.



# The challenges we face

The challenge for the textile industry is finding suitable sustainable fabric alternatives, many still requiring research and technological development (RTD). This RTD will need to be conducted in partnership with our customers, our mills, our employees, as well as available sustainable resources (natural or recycled).

But, change cannot be immediate, nor can it be broadly applied. To be effective, we need to focus our attention and establish specific, measurable, achievable, relevant, and time-bound goals (SMART). Our goals have been centered on 5 key SDGs, that are within our core spheres of influence:



Decent work and economic growth for ourselves and our partners



Responsible production & consumption of our textiles



Taking climate action by understanding our footprint, up and down stream



Transparency and traceability of all our products



Partnerships internally and externally of our business to ensure positive change



# Understanding our impact

In 2021, we took our first step to understand our carbon footprint. We did this for two reasons;

- To understand where our carbon emission hotspots lay (direct and indirect)
- To understand the start point from which we could begin to reduce our footprint.

Our 2023 pillars of impact are:

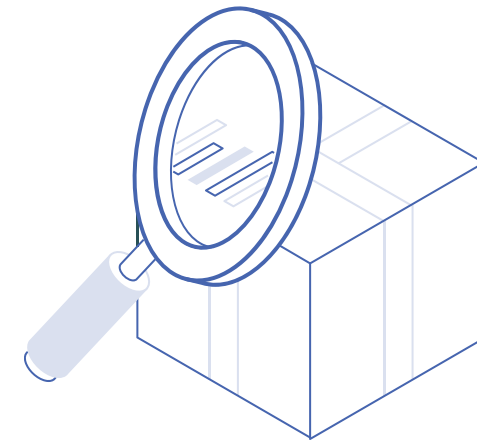

## Products

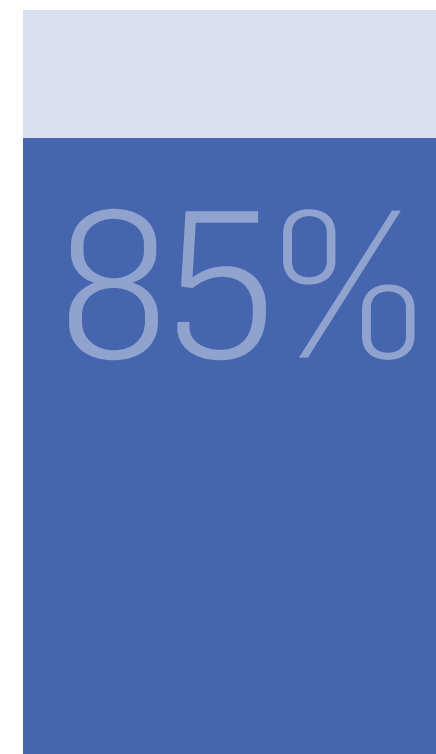

More than 80% of our carbon emissions are caused by our products, where our direct impact is limited

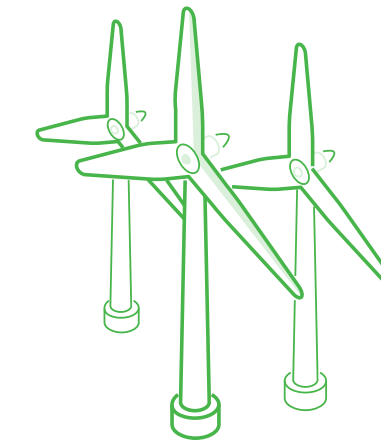

## Operations

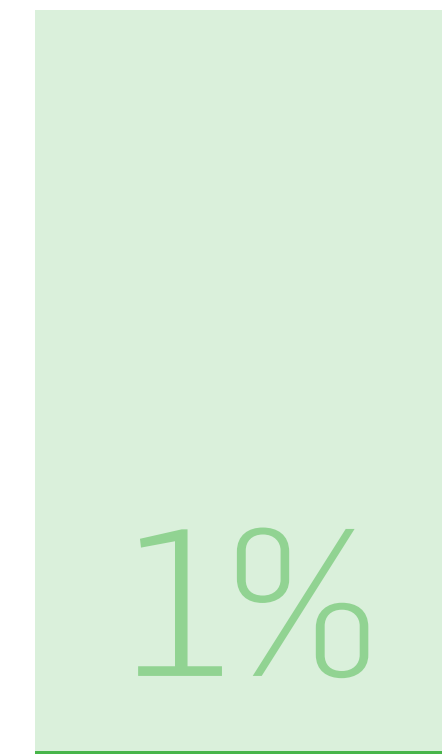

Less than 1% of our carbon footprint is due to our own operations which is in our direct control

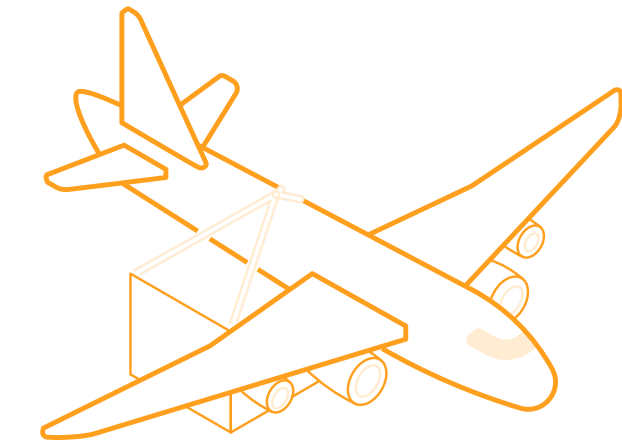

## Transport

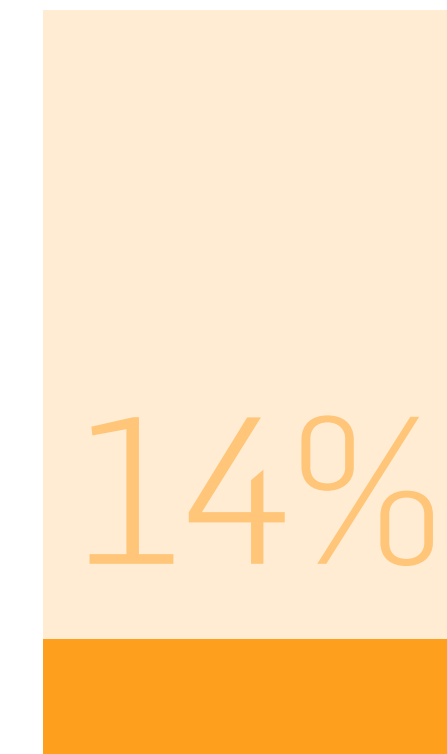

14% of our carbon footprint is due to the transportation of our products across the globe

Bru Textiles 2023 Data

# Products

We believe in the quality of the product we sell. However, we understand that our fabrics have **embodied energy** and that more sustainable choices are the pathway to a secure future. We also understand that we need to inspire change, together with our suppliers, source innovative fabric and transportation solutions that are fit for purpose, and migrate to green energy sources.

## Fabrics have an environmental impact, beyond carbon

Textile production worldwide has a significant impact on the environment, from the use of raw materials, water and related pollution, chemicals, and waste.

The impact from these fabrics depends on the different processes used during production; from raw material choice, through to yarn production and textile formation and finally, dyeing and finishing.

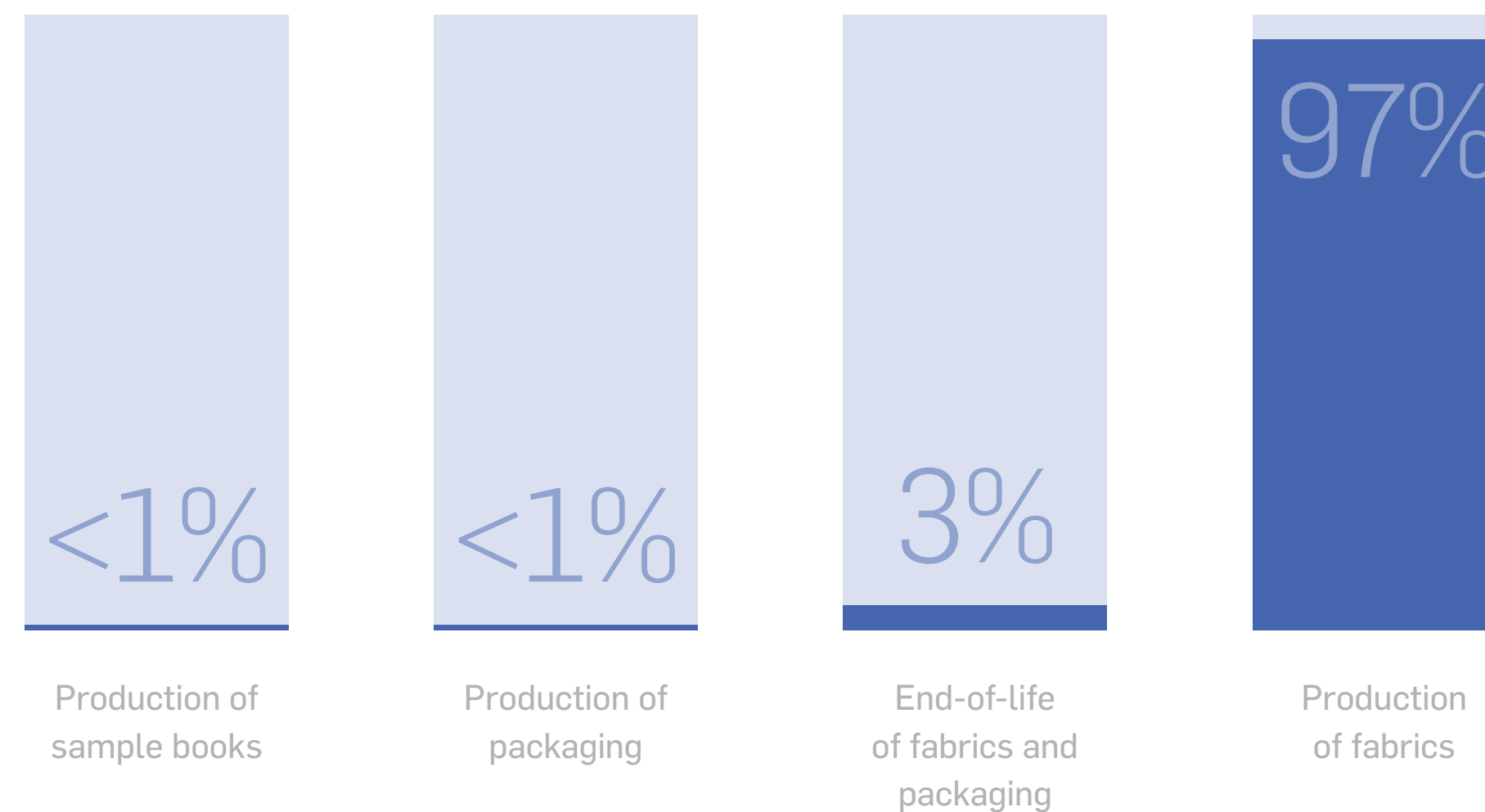

Bru Textiles 2023 Data

10%

The textile industry category, which includes household, technical fabrics, fashion & clothing are responsible for approximately 10% of [all global emissions](#).



“We continue to source the best available sustainable solutions.”



# Products

## Higg Index

To assess the impact of our products, we use the [Higg Index](#). From our research, this is the most comprehensive tool available, providing a wide range of environmental metrics, based on a large variety of textile compositions and manufacturing processes used.

Using the Higg Index, we can assess the following:

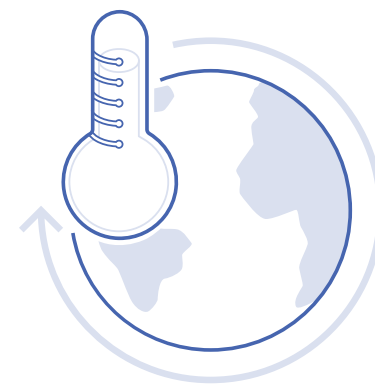

Being an energy intensive process, fabric production has a significant contribution to [global warming](#). We now understand the fabrics embodied energy and how to improve this and/or make alternate fabric selection decisions and moving to green energy alternatives

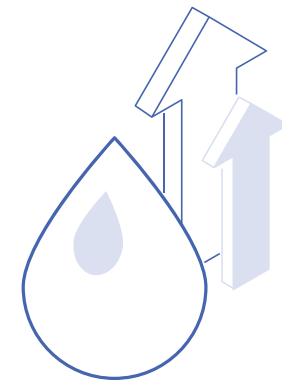

Natural fabrics consume a large amount of water during production and contribute to [eutrophication](#). The selection of these types of fabrics can now be limited by understanding the data from Higg

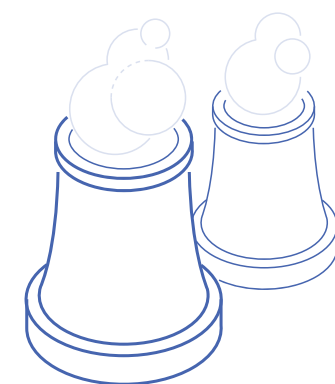

The production of fabrics leads to [resource depletion](#) by consuming raw materials at a faster rate than they can be replenished - e.g., by burning fossil fuels

There is no silver bullet when it comes to choosing the “right” fabric

There is not a single fabric that has zero footprint across all impact categories.

However, when we look at insights from the Higg Index for our material selection, we can conclude that recycled polyester is currently one of the better choices.

- Bru will increasingly include fabrics into our offering that are less carbon intensive, but we remain dependent on commercial availability and industry innovations.
- Scientific innovation, partnerships, and a drive to deliver sustainable solutions will ensure that the industry increases sustainable alternatives in the coming years.

# Operations

We have come to understand that the small things are always the big things and although our direct control over textile production is limited, we cannot expect change within the industry if we do not take measures ourselves.

## The small things are the big things

We have implemented actions to help reduce the impact from our own operations, understanding that decarbonising our energy supply is the global challenge we all face.

Electrification, combined with renewable electricity production and storage, is the key to responding to this challenge.

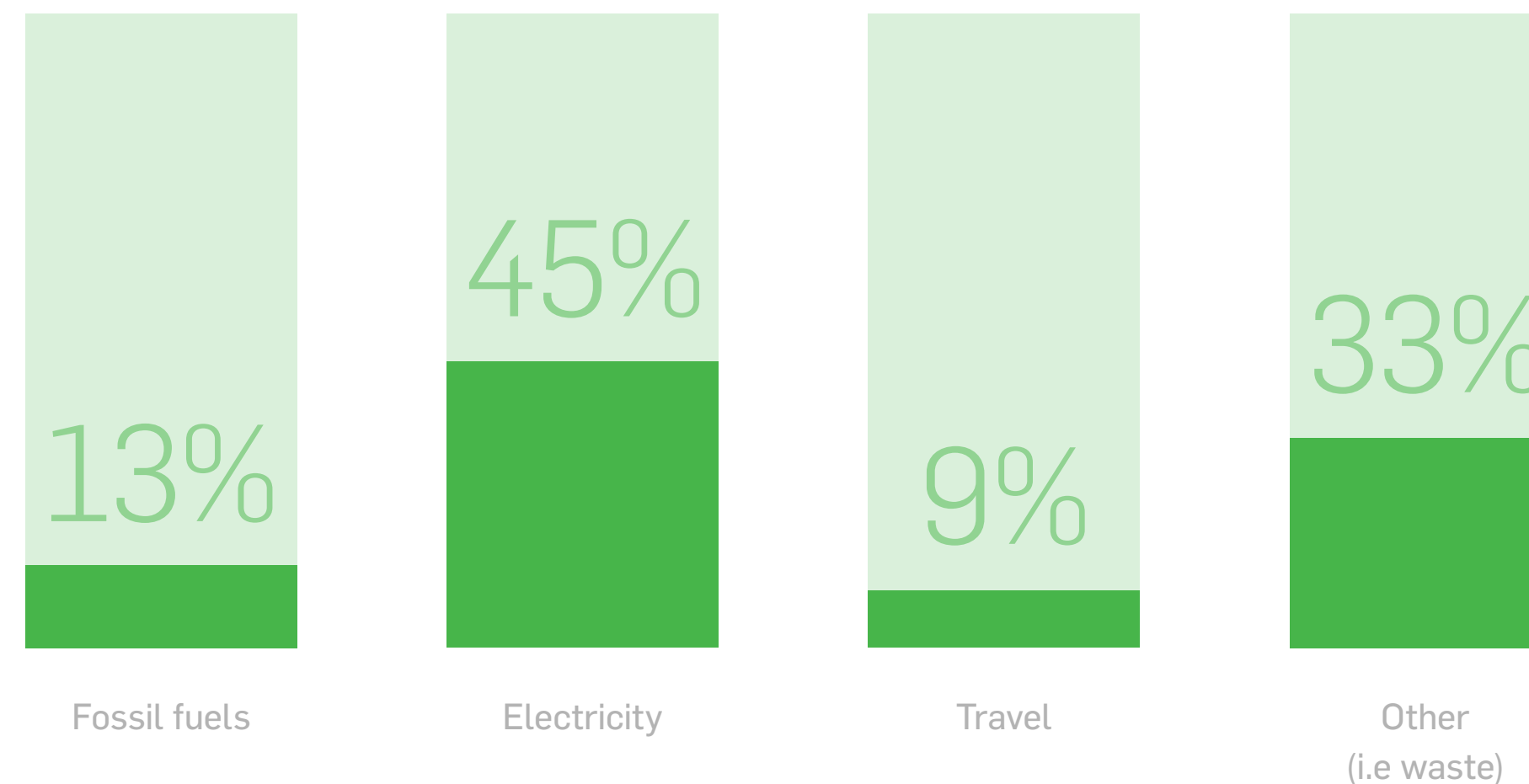

Bru Textiles 2023 Data

## Bru Textiles is ISO 14001 certified

ISO 14001 is an international standard that specifies requirements for an effective environmental management system (EMS).

Bru has proudly created an ISO 14001 framework, which helps improve our environmental performance through more efficient use of resources and the reduction of waste. As of January 2023, Bru Textiles is proudly ISO 14001 certified.



# Operations Carbon footprint

To reduce our direct emissions, we are focusing on our energy consumption and changing the mobility of our employees.

## Making an impact on the ground

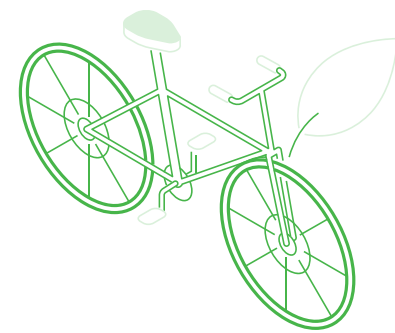

Our corporate fleet is comprised of 70% electric vehicles and where applicable, we have facilitated the use of alternative mobility for all our employees

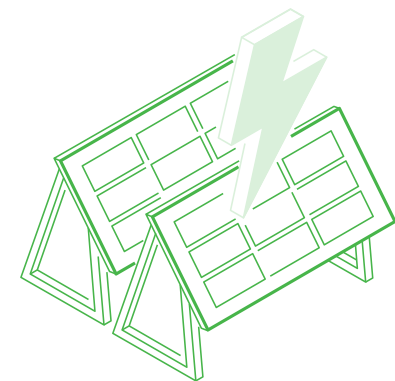

We want to shift to (self-produced) renewable electricity wherever possible, but unfortunately, we cannot reach 100%, yet

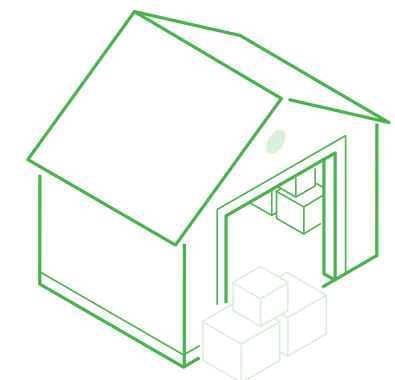

Our fully automated warehouse, the largest in the textile industry, is powered with renewable energy, which is based on solar energy

## The shift to renewable energy

Our mission is to move to fully renewable cooling and heating energy sources, as new improvements become available for our Belgian based headquarters.

## Evolutionary average of CO<sub>2</sub> emissions (active fleet)

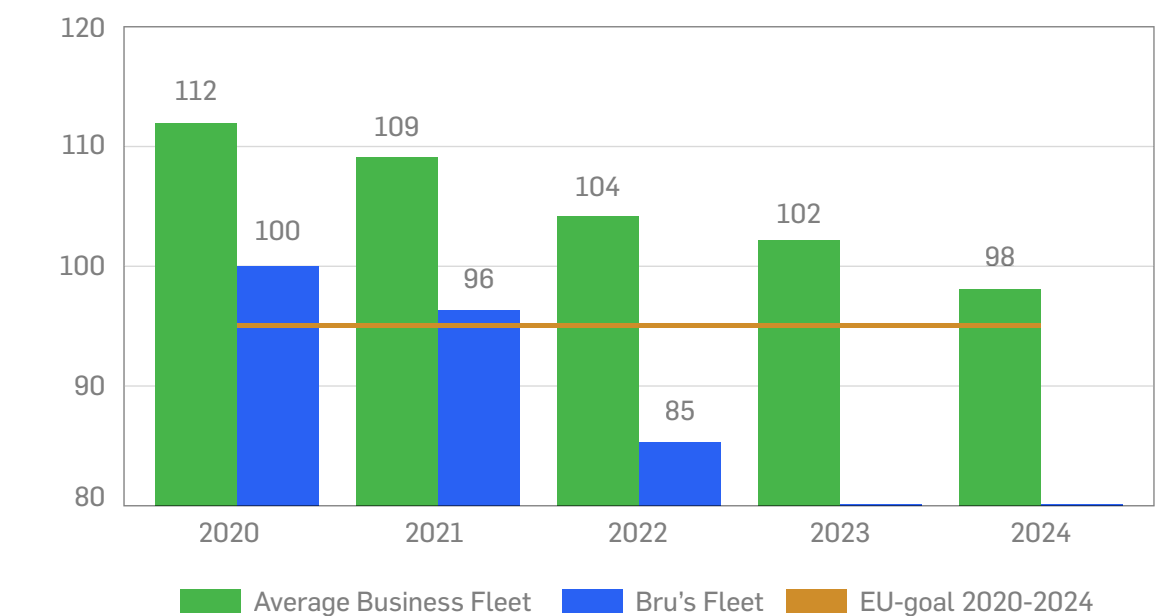



# Operations Carbon footprint

From 2014 to 2024 Bru Textiles has grown the number of solar panels available from 1200 to 2800 panels. This growth has ensured the maximum production of solar energy required to run the Belgian based office solely on green energy.

Solar power (kWh)

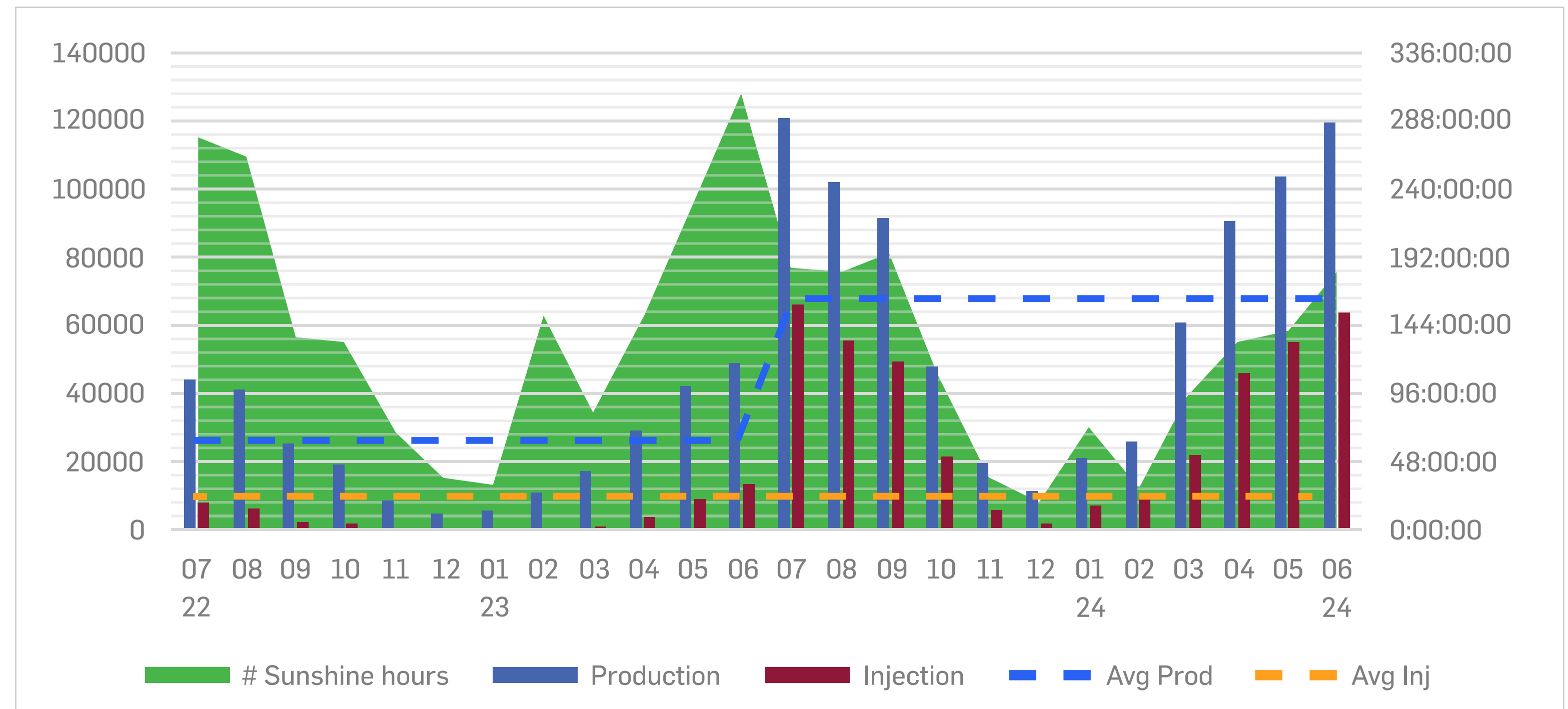

Our average production (seen with the blue dotted line) has increased from 22 000 kWh to 64 000 kWh from 2023 to 2024. This has resulted, even with fewer full sunshine days.



# Transport

Being a global player, we ship our goods worldwide. This transportation contributes to the life cycle emissions of our products.

## Shipping is an important part of our business

We cannot avoid it, but through smart management and informed choices, we can reduce our impact. However, not all transport is within our range of influence, especially outbound. We are focusing more effort to work collaboratively with our clients, in order to reduce the emissions from these transport streams.

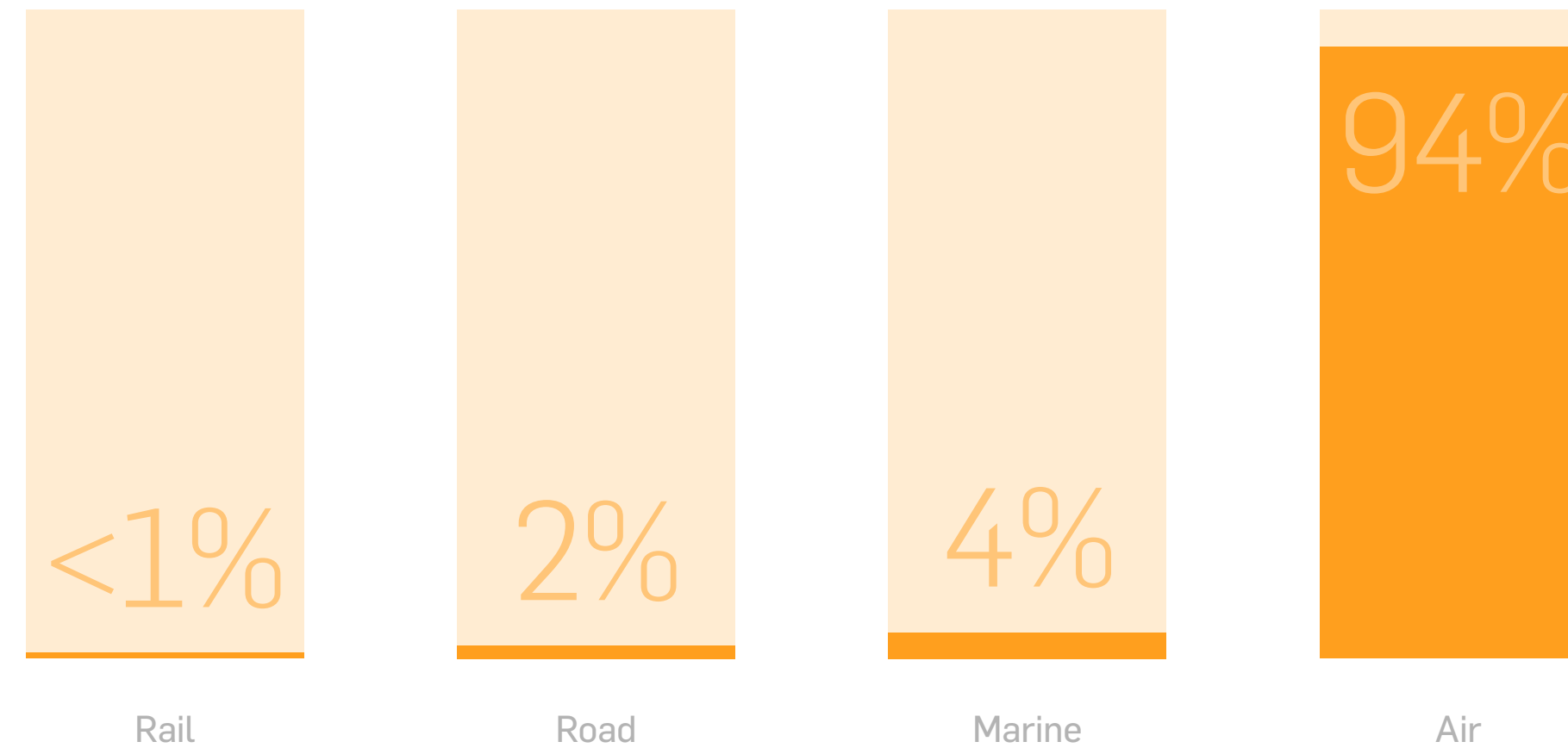

Bru Textiles 2023 Data

## Our calculated impact

To assess our impact, we calculated the emissions from transportation for all modes of transport, including all in- and outbound shipments. We estimated the average transport distance using geolocation of the point of departure and destination and an average distance correction factor.

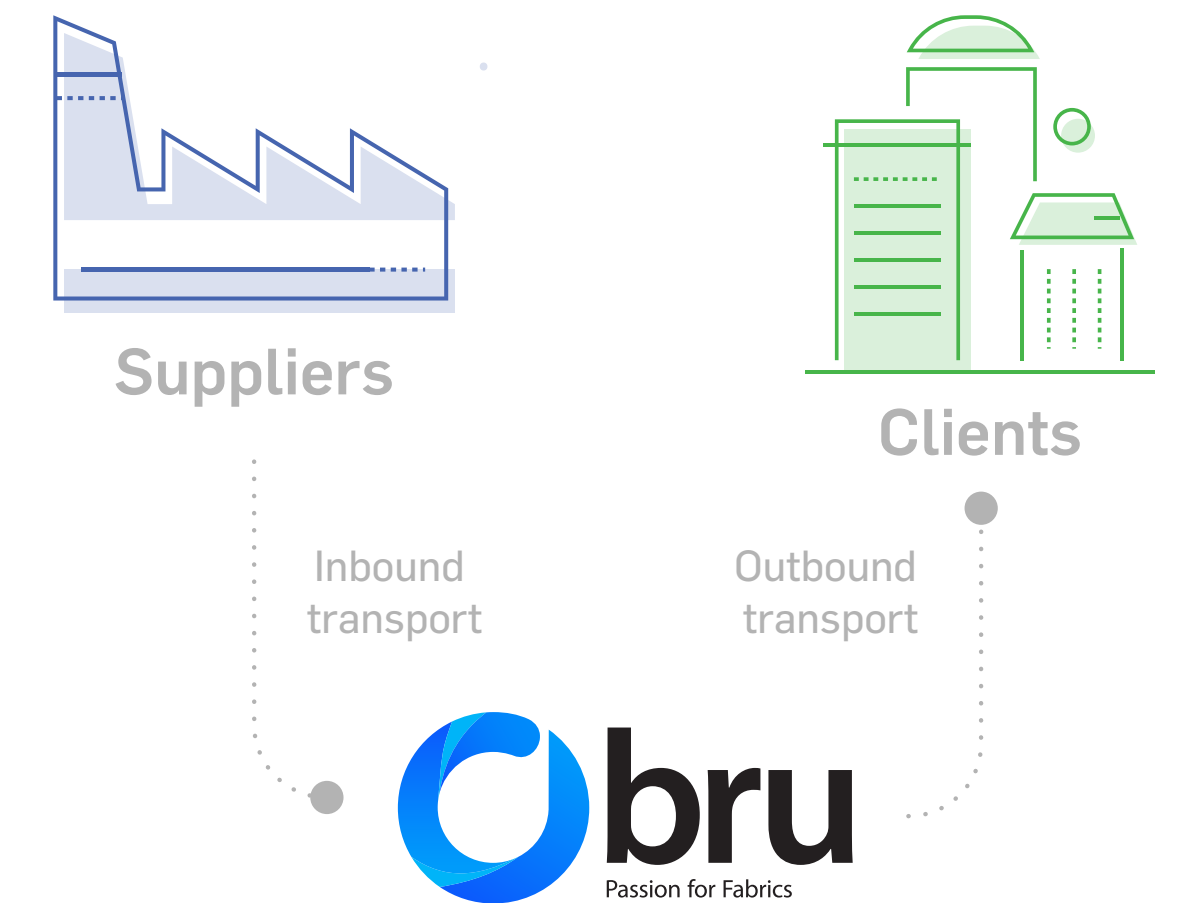



# Transport

## Air freight

Air freight emits up to 10 times more CO<sub>2</sub>-emissions per transported kilometer when compared to truck freight. Often, goods are shipped by air to meet a clients' urgent needs. Therefore, goods stock management and collaboration with our clients is required to shift this transport from air freight to a lower impact transportation mode.

### Reducing our distribution emissions

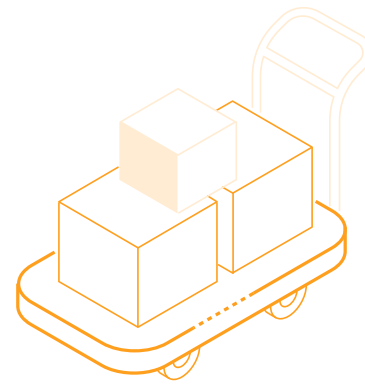

To reduce our emissions from transportation and distribution we must rethink our current models and optimise transport streams, stock levels and regional warehousing

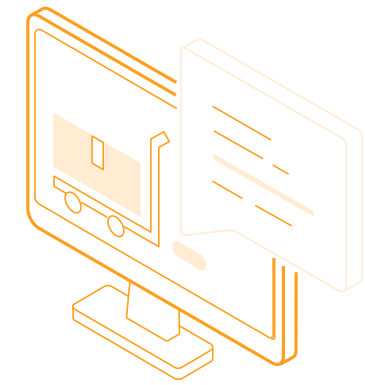

We use real-time information to help us forecast demand and scenario planning, reducing the km's travelled of our product



In other words, we have a better view on data and can manipulate this to optimise the outbound and inbound streams, as well as shipping locations

### Increased storage

We will also be expanding our warehousing, ensuring that product is shipped to its closest destination, once.

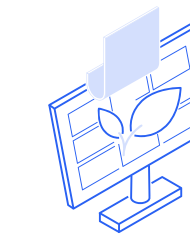

### Digital sampling

With our digital sampling offering we aim to avoid CO<sub>2</sub> emissions from transportation and distribution



# Driven by quality

Operationally, we run our business guided by Quality Management, which concerns all topics related to Quality, Environment, Safety and Health and well-being (QESH).

## Quality at the heart of it all

It is something that governs all our operations, end to end. Our QESH team monitors our compliance, new legislation, decent working hours and best practices throughout the industry. They are also responsible for making sure we successfully receive our ISO 9001 certification each year.

Fundamentally, we are a business that believes in the enrichment of our people and the planet in which we live, and understanding our impact is key to our sustainability strategy.



## Investing in our people

An involved and motivated employee team is key for a successful business. By creating a healthy and attractive working environment, Bru Textiles wants its employees to thrive. To achieve this, we are investing in the ongoing development of the team, both in terms of building knowledge and expertise as well as skills and personal development plans.



**“Our staff have access to mental well-being programs and a person of trust who acts as a staff confidante in times of distress.”**



# Equal opportunities

Bru Textiles also believes that for it to thrive and grow as a company, the boardroom should be diverse and inclusive.

## Nurturing talent

Today, diverse talent is still underrepresented in decision-making. In the coming years, Bru Textiles will build a strong pipeline of multi-represented talent. To attract and retain qualified, talented people we are developing a diversity strategy suited to environmental needs. In the short term, we will analyse specific barriers within the company, including those in the hiring process, assignments, promotion, and trainings, and remove them. In addition to a strong top-level commitment, we will launch a leadership program to identify, nurture and value talented female employees and create an enabling environment.



## Safe conditions for all

We want to create an impact for all workers and society beyond our own employees. Today, the textile industry is still associated with problematic socio-economic factors, such as scarce labour rights, dangerous working conditions and lacking human rights. Bru Textiles is aware of this and cares about all workers in the supply chain. To ensure decent working conditions for all, we strive to only work with strategic suppliers that show excellent social performance in line with a Supplier Standard that will be developed in the coming year.



This year we welcomed Gemma Powers to our Bru Textiles Group Board of Directors.



# Paying it forward

To drive positive impact in local communities, Bru Textiles invests and gives back to local communities, which currently includes these NGO's and institutions.

## LIVE AND GIVE

### Live and Give

Live and Give is a Belgian-based foundation that works to help disadvantaged children in Vietnam. Live and Give has successfully built a boarding school and orphanage in Pleiku, Central Vietnam. 9 additional schools have also been constructed which contribute to improved living conditions for the poor people of Vietnam.



### Sentana Stiftung

Sentana Stiftung is a German foundation established to create a meeting place for lonely and ageing people and animals to meet and nurture each other. Sick and/or abused animals are cared for in this unique sanctuary while giving further comfort to their human friends.



### Doctors without Borders

As part of our charitable initiatives, Bru supports Doctors without Borders, the international medical humanitarian organisation that brings emergency medical aid to humanitarian crises around the world.



### UZA Foundation

The UZA Foundation supports groundbreaking research within University Hospital of Antwerp (Universitair Ziekenhuis Antwerpen). Bru is strongly committed to supporting extensive research related especially to premature births, and in following the development of premature infants during their entire journey to adulthood.



### UNICEF

UNICEF works in over 190 countries and territories to save children's lives, to defend their rights, and to help them fulfil their potential, from early childhood through adolescence. Every year Bru raises money for their projects worldwide, in a mission to help the most vulnerable children.



### Berrefonds

Berrefonds provides support and tailored programs to help families who have lost a child. Bru contributes to this incredible organisation and the amazing work they do, ensuring families feel supported and heard.



# Eco fabrics

Together with our suppliers, Bru has committed to integrating eco fabric compositions, such as Global Recycled Standard (GRS) and Organic Content Standard (OCS) yarns, into our collections. These fabric yarns have lower carbon emissions (as per our Higg data), and are also produced in ISO 14001 mills.

In 2025, 100% of Bru's launched products will be eco fabric compositions.

Eco Fabrics: SKUs launched per year

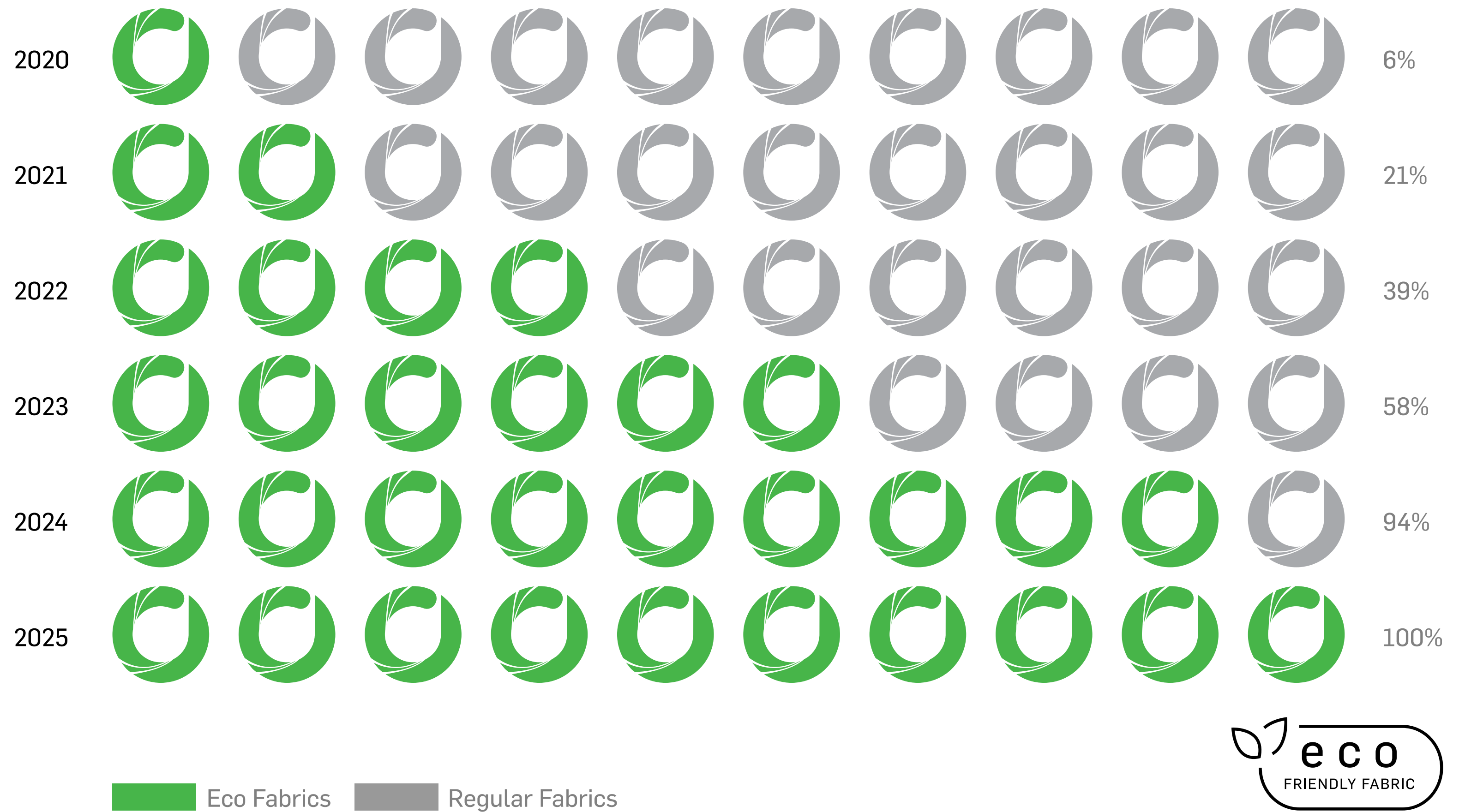



# Digital sampling

We believe that we can make a large contribution to sustainability by re-inventing samples in our industry. Physical sampling has been an important aspect in our business and physical communication with our customers.

## The move to digital

As we innovate and evolve into digital, we are striving to rationalise the number of sample books we produce and will continue to develop our digital offering via our own platforms and/or [technological partnerships](#).

The development of our digital offering, through Twinbru, is one of our core sustainable innovation directives. The simple concept behind this is that one digital image has far greater reach potential to customers, compared to a single physical sample book or hanger that reaches fewer customers. Physical samples have a carbon footprint:

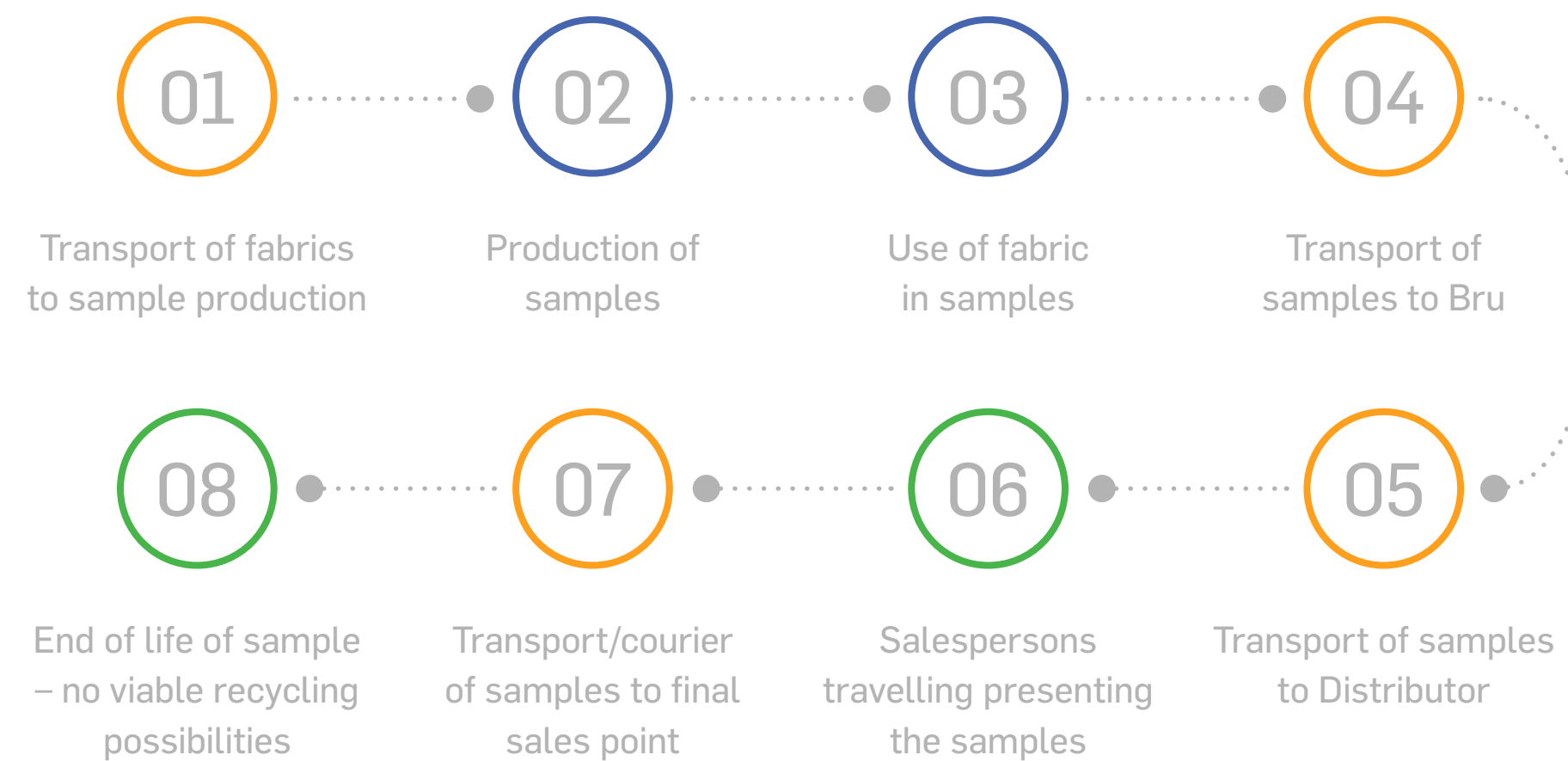

## Future potential

This entire process has the potential to be partly replaced by digital platforms, which will reduce the carbon footprint and improve the economic stream for the industry.



“Within the next three to four years, we expect to significantly reduce the carbon waste associated with physical samples.”



# ISO 14001 standard on environmental management

We monitor our mills' compliance with the ISO 14001 standard on environmental management, empowering them to develop practical systems so that we can all manage our environmental responsibilities together.

## International standard

ISO 14001 establishes the criteria for an environmental management system and can be certified. Designed for any type of organisation, regardless of its activity or sector, it provides assurance that the environmental impact of operations is being measured and improved. The benefits for our customers are:

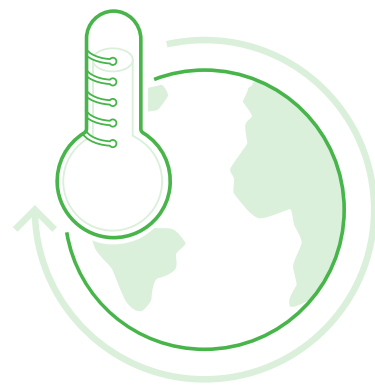

Minimised collective environmental footprint

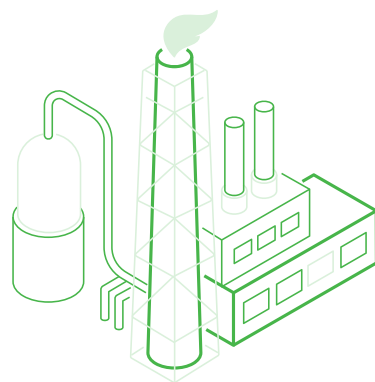

Diminished collective risk of pollution incidents

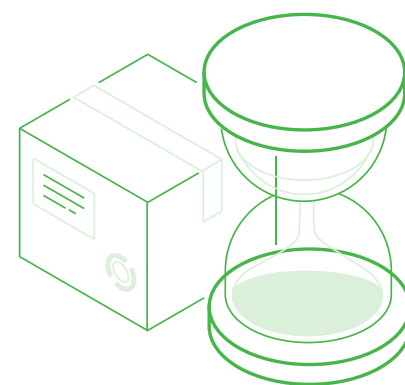

Operations systems are continuously improved

100%

100% of our products are purchased from ISO 14001 certified producers.

**ISO 14001**  
Environmental  
Management



# Our operations

We have focused on reducing our paper consumption, with most work conducted as paperless, and screen based. Recycling is a priority, with recycle containers on site for all staff to utilise in their day-to-day operations. All incoming packaging materials of our products are recycled.

## Reduce, reuse and recycle

Internally of our business operations, we have identified initiatives to reduce, reuse and recycle, which currently include:

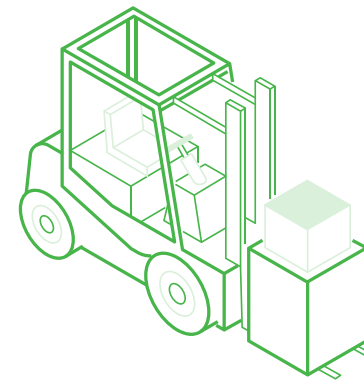

Stillage returns program with our customers

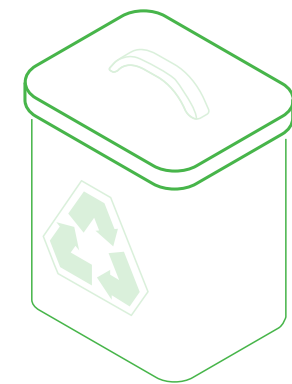

Implementing ways to reuse and recycle on-site fabric off-cuts and fabric waste

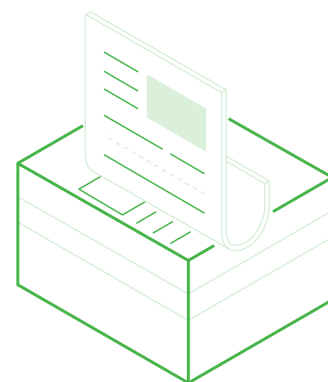

Investigating alternate paper and printing techniques to produce physical samples, making for more eco-friendly alternatives

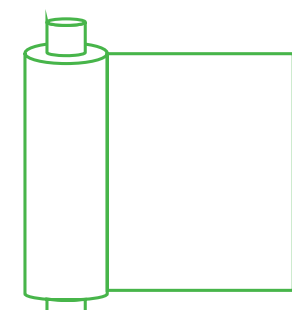

All our products are carefully packaged and shipped in FSC cardboard and recycled plastics. We do not use any virgin plastic to protect our products.



**“Forward-thinking sustainability is engrained in our company culture through visible sustainability projects and actions taken throughout Bru.”**



# Eco standards

We have been working with many of our suppliers for as long as we have been in business. Our relationships have adapted to market demands and this has been no different with our push towards more sustainable products and ensuring responsible consumption behaviours.

We have also understood the role regulation and certification plays when considering textiles and textile production. Our eco standards are critical of the promise our suppliers make to us, and the promise we then extend to our customers. Currently, our transparency and traceability, and eco certification includes:

## REACH REACH

REACH (Registration, Evaluation, Authorization and Restriction of Chemicals) is a compulsory EU regulation that establishes procedures for collecting and assessing information on the properties and hazards of substances. It's a regulation set up under the European Chemicals Agency (ECHA). Our fabrics therefore consistently comply with these mandatory REACH regulations.



## STANDARD 100 by OEKO-TEX®

All Bru fabrics are certified under the STANDARD 100 by OEKO-TEX®. The STANDARD 100 is a product label for textiles and accessories that have been tested for harmful substances. Products certified with OEKO-TEX® do not contain any harmful substances and this certification system is in many cases more comprehensive and stricter than required by national and international standards. The STANDARD 100 by OEKO-TEX® certification means more transparent supplier relationships upholding a consistent standard of excellence. The test criteria are globally standardised and are updated at least once a year based on new scientific information or statutory requirements. Our unique STANDARD 100 by OEKO-TEX® number is 0611045.



## Global Recycled Standard (GRS)

The GRS is a standard of verification for companies to determine the recycled content of their fabrics. It ensures that corporate claims concerning recycled content of textiles are accurate and up to date. This standard is audited on an annual basis by assessing the production, trading, and manufacturing processes to ensure the recycled content of our fabrics is authentic. Our unique GRS number is 1036513.



## Organic Content Standard (OCS)

The OCS is a certification awarded to goods that are guaranteed as containing organic content such as organic cotton. Each party involved in the chain of production, from yarn supply through to finished goods, is closely audited, and controlled to ensure the item contains genuine organic content.



Based on their composition, fabric is either awarded the 'Organic Content Standard 100' for fabrics containing more than 95% organic fibre, or the 'OCS Blended – Organic Content Standard' for fabrics containing between 5% and 95% organic fibre. Our unique OCS number is 1036513.



# Building relationships



## In it together

The most important aspect of any sustainability journey is that of partnership. Interwoven into our story to more sustainable practices are the stories of relationships and how we are all in this together. Bru cannot act in isolation and be successful, we need our suppliers, customers, employees, communities, and organisations so that we can share what we have learnt and innovate together.

As such, we have formed key relationships with:



### Futureproofed

Expert sustainability consultancy.



### The Higg Index

Higg Materials Sustainability Index (MSI), which is a lifecycle assessment tools providing insights into the environmental impacts of producing materials and products.

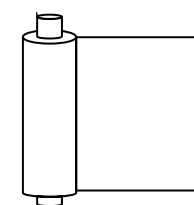

### Our Key Mills

Together with our key mills and suppliers, we are working together to understand our carbon footprint data and how to improve this for all single fabric composition types, using the Higg MSI tool.



# Our learnings shared





# Everyone's responsibility

We want to engage with all our stakeholders to do the right thing.

## Challenging our partners

Our strategy has included playbooks for suppliers and partners, where we are able to assist in joint paths to sustainability. These playbooks include:



Understanding how to calculate your carbon footprint and steps to reduce it



Responsible consumption and production and using the Higg Index to calculate and manage fabric selection



Sustainably understanding fair labour practices, diversity, and inclusion

## A better future for all

We are continuing to expand these playbooks, as our learning and experience within areas grows.

We want to share our continued sustainability journey, the lessons we have learnt (and will continue to learn!), provide insights regarding the impact of our products, and keep you informed about our ESG progress.



**“We invite you to join us – together we can make a difference!”**



# Sustainability is every person's responsibility



Copyright © 2022 Bru. All rights reserved.  
Head office: Bru Textiles nv, Satenrozen 2A, B-2550 Kontich, Belgium  
+32 3 451 8000 [info@brutex.com](mailto:info@brutex.com) [www.brutex.com](http://www.brutex.com)